

**Check Point**  
SOFTWARE TECHNOLOGIES LTD

# CloudGuard

## Architecture Blueprint Diagrams

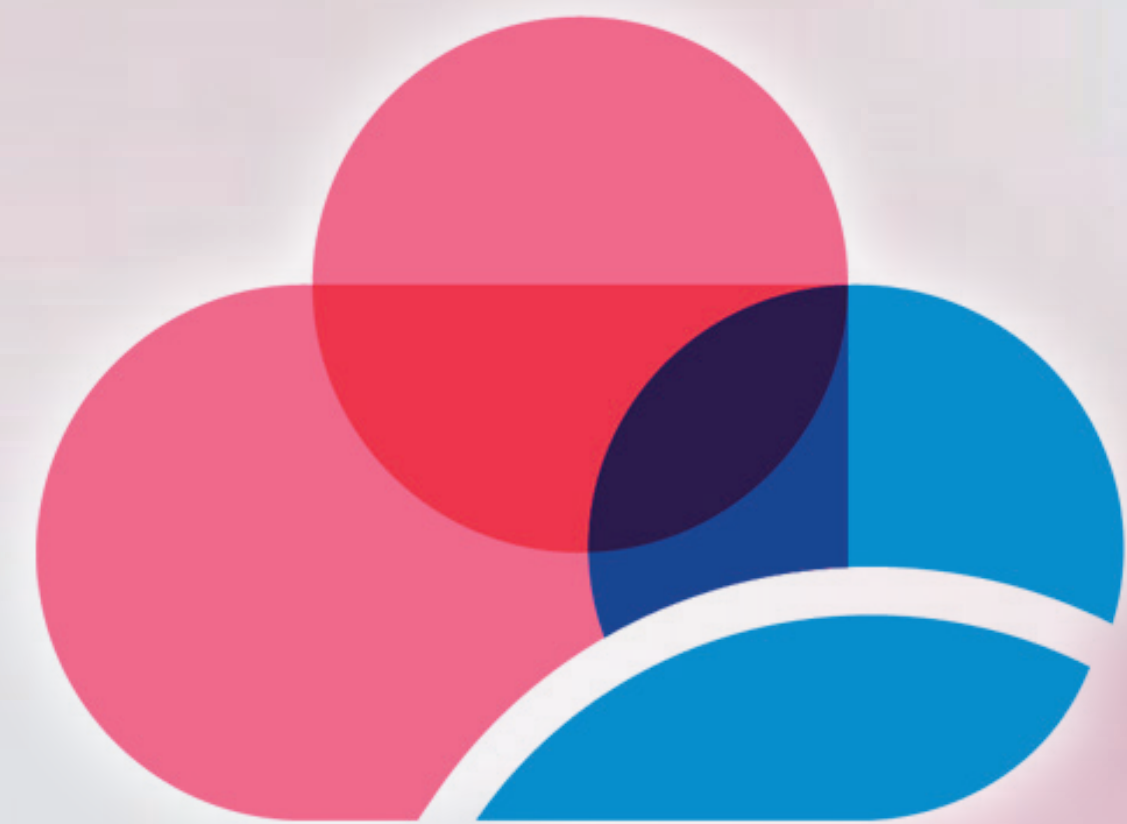

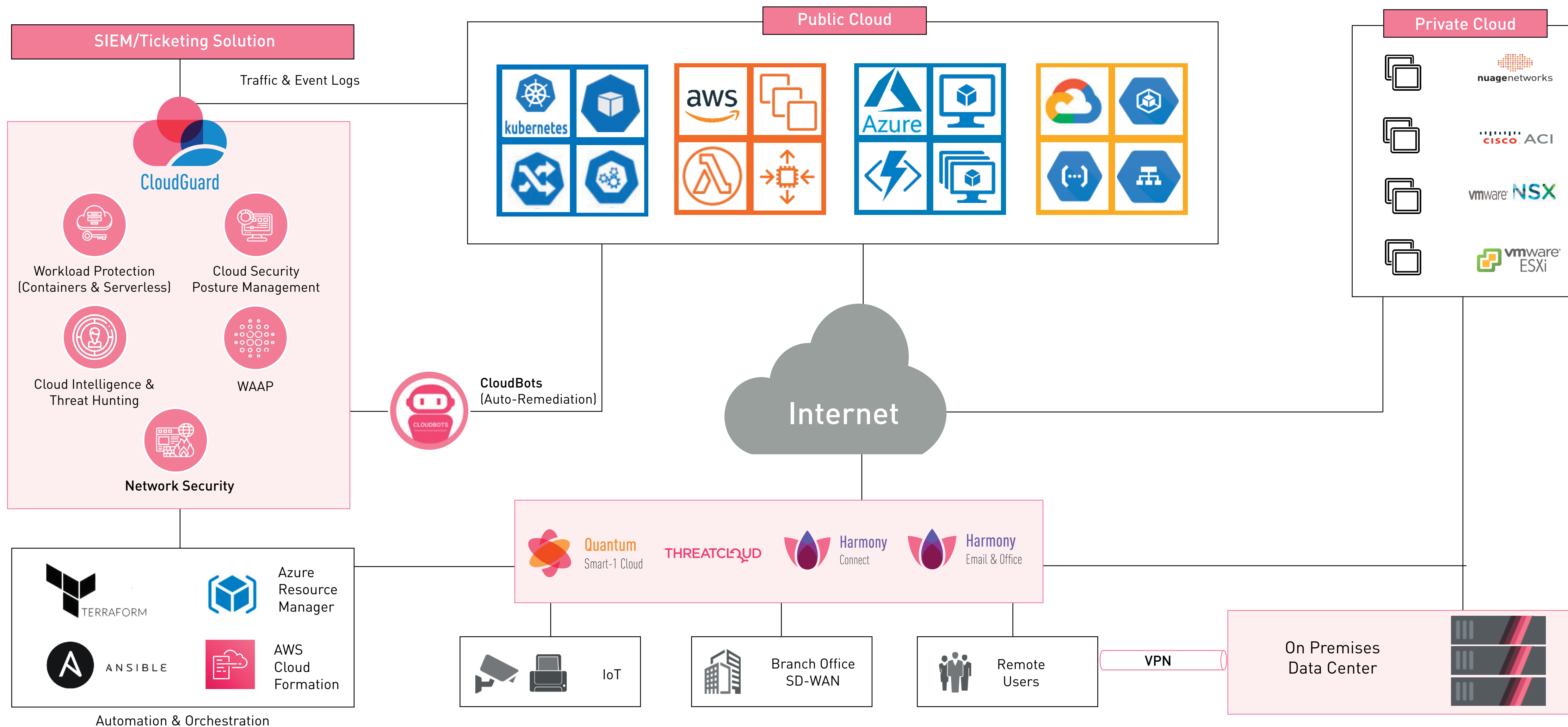

### Network Security

- Advanced Threat Prevention & Traffic Inspection
- Common Policy and Logging Infrastructure
- Unified management of physical and virtual infrastructure
- Automated deployment through IaC
- Dynamic policies map to cloud through tags and metadata
- Support also for Oracle, Alibaba Cloud, IBM, and more

### Additional Cloud Security Capabilities

- Continuous Compliance with Industry Frameworks and Best Practices
- Identify misconfigurations in IaaS and PaaS
- Automatic Remediation integrated natively
- Workload Protection for Kubernetes clusters and Serverless functions
- “Shift left” security posture into CI/CD pipeline
- Consumes & correlates cloud native network and audit logs

### Overall Architecture:

- ThreatCloud delivers real-time dynamic security intelligence from a collaborative cloud driven knowledge base
- Holistic security view
- High Fidelity context for Threat Hunting & Intelligence
- Extensive APIs across the CloudGuard suite

# Single Hub Architecture

Ideal for small environments with little prospect for growth (not very scalable)

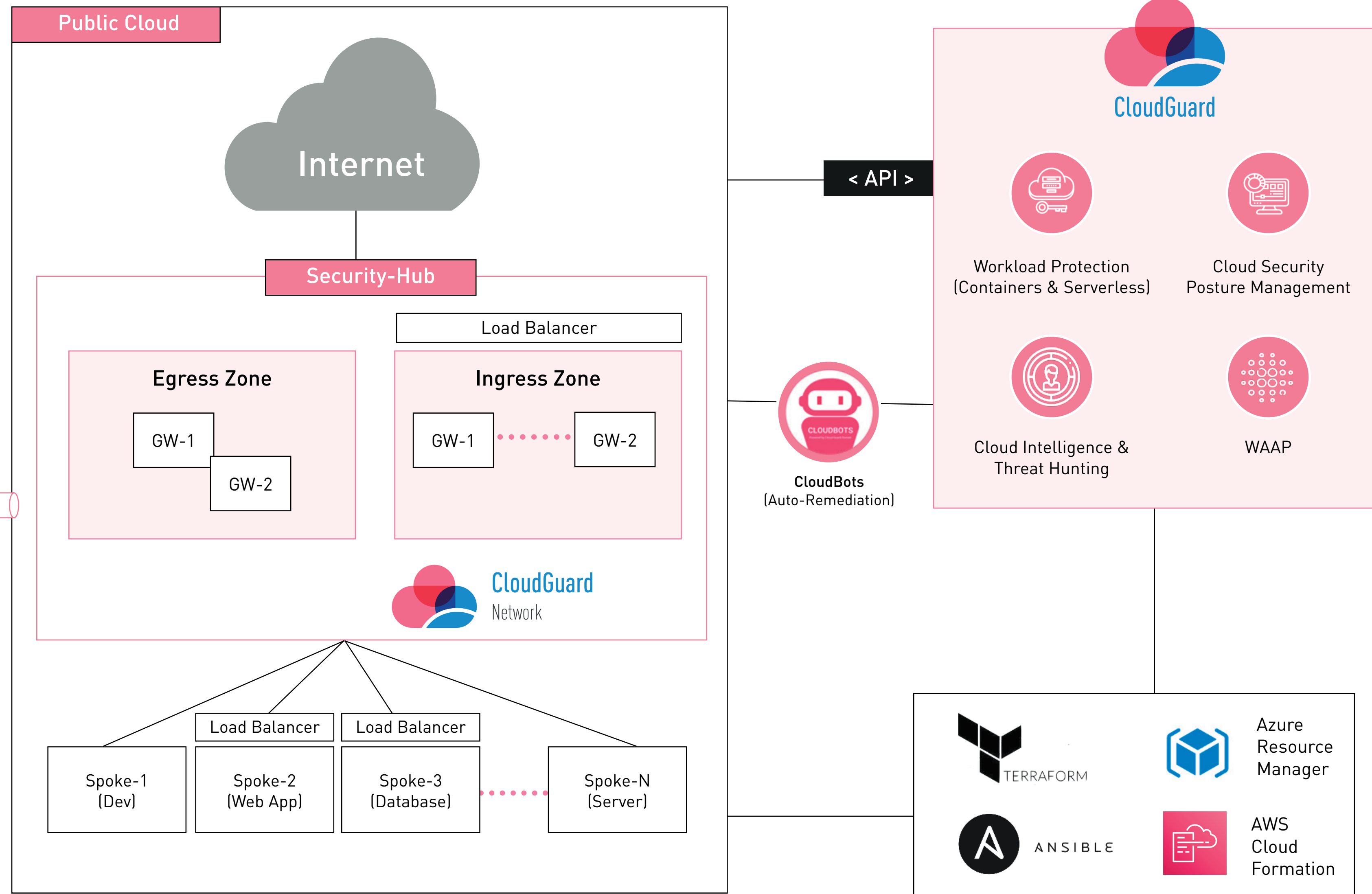
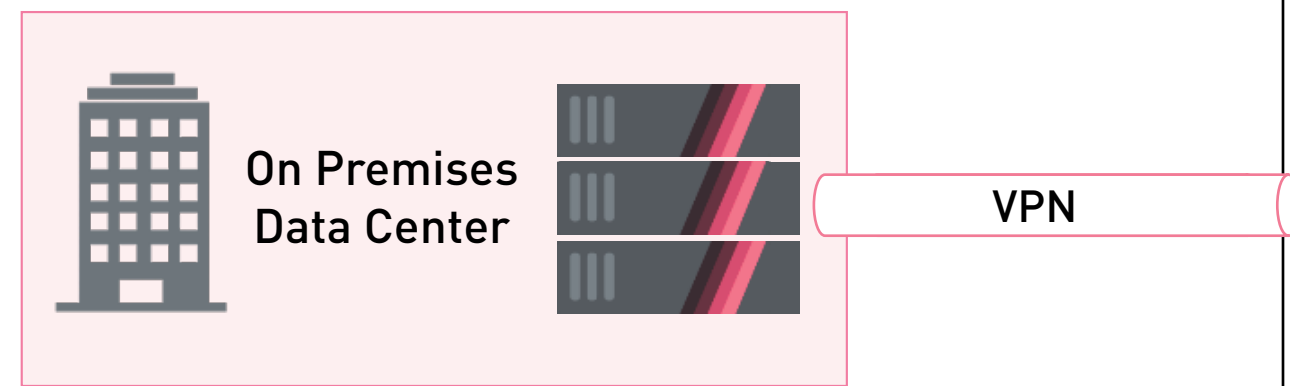

## Values

- “Network perimeter” security with Advanced Threat Prevention
- Simple architecture deployment
- Agility, Automation, Efficiency, Elasticity
- Unified management for hybrid environment

## Architecture

- The Single Hub (VPC or vNET) acts as a central point for the security of the entire cloud environment.
- Ingress & Egress Zones for North/South Traffic Inspection
- Ability to add East/West inspection between VPCs, VPN, or MPLS connections
- Flexible deployment templates for single gateway, HA clusters, or Auto-Scaling group
- With Auto-Scaling groups, automatic scale out and scale in based on load and performance
- Spokes represent a virtual network where different assets are deployed.

Automation & Orchestration



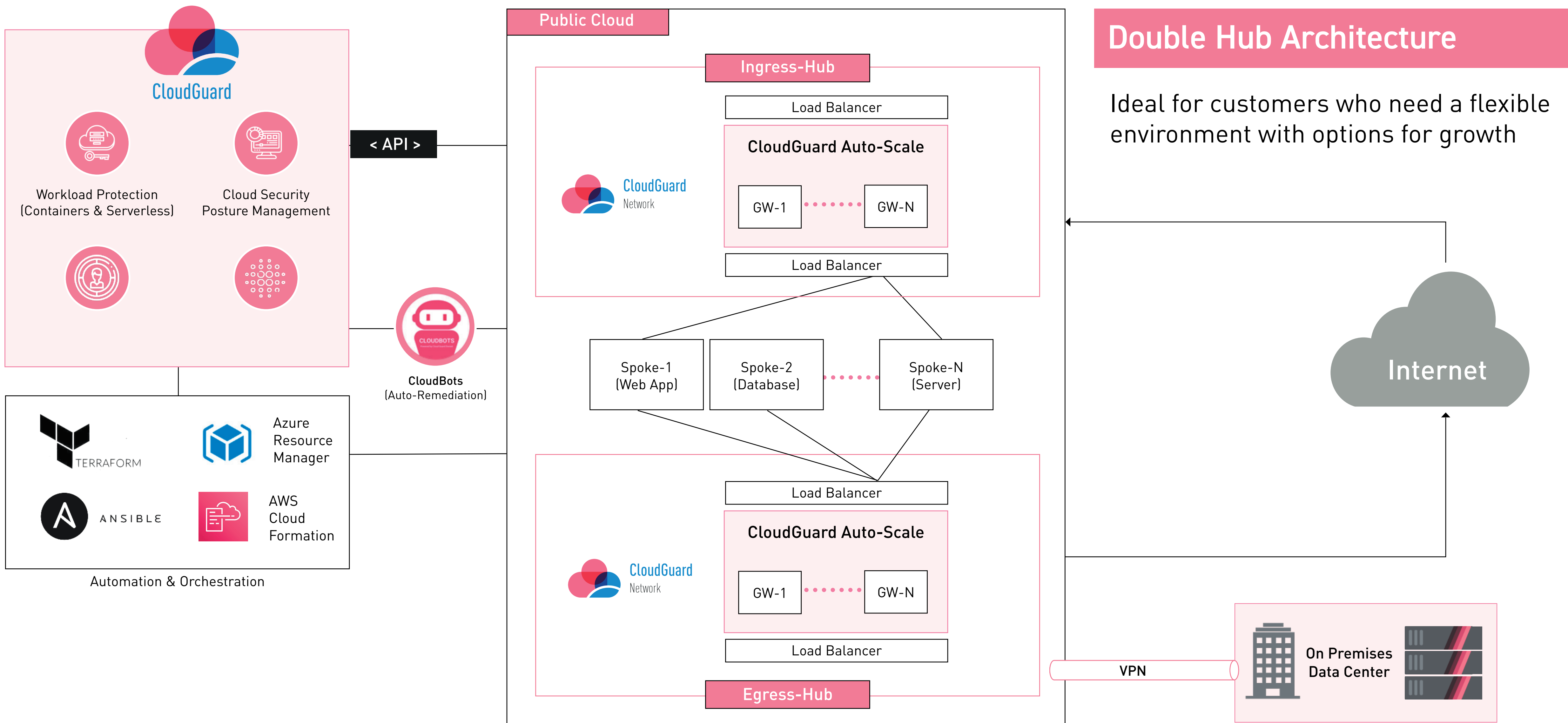

# Double Hub Architecture

Ideal for customers who need a flexible environment with options for growth

## Values

- Automation of deployment, scaling, and policy enforcement
- Enhance Cloud Native tools with Advanced Threat Prevention
- Ease of enforcement on traffic through cloud networking
- Segmentation of internet facing and private facing traffic

## Architecture

- Double Hub Architecture segments and enforces security controls on traffic entering or exiting a spoke.
- The Ingress Hub deploys Auto-Scaling gateways that handle fluctuating levels of traffic from the Internet.
- The Egress Hub is responsible for East/West traffic between spokes, outgoing traffic to the Internet, and corporate traffic from the On Premises Data Center.
- Flexible deployment options for standalone, clusters, and auto-scaling to meet resiliency and performance requirements.

This Architecture is the official Check Point recommendation.

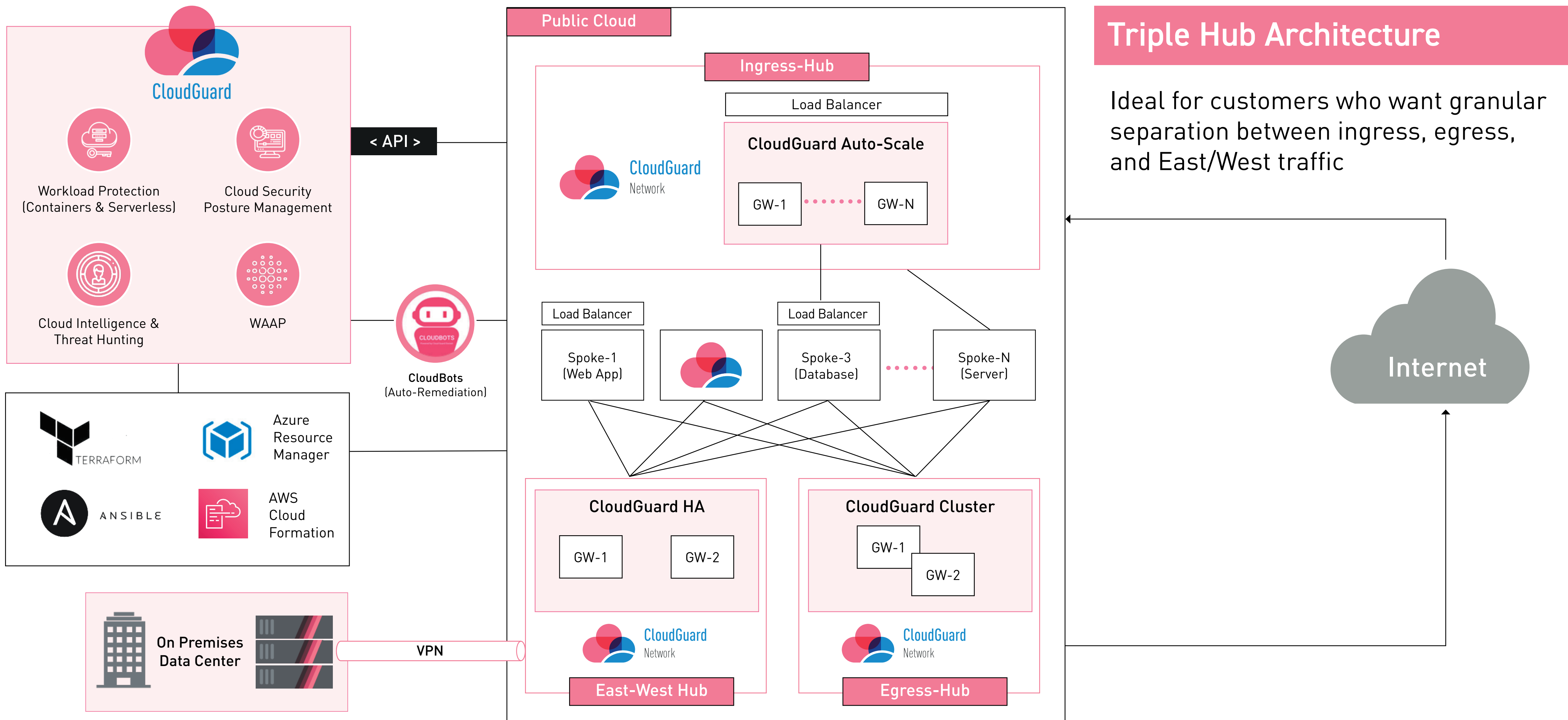

# Triple Hub Architecture

Ideal for customers who want granular separation between ingress, egress, and East/West traffic

## Values

- Internet connected North/South traffic uses dedicated security zone
- Options to separate East/West hubs and Egress Hubs
- Separation for performance, change management, and maintenance
- Zero Trust Model

## Architecture

- Triple Hub Architecture offers the most separated architecture and adheres the most to a Zero Trust model.
- This architecture segments the different traffic flows with security controls on each hub.
  - The Ingress Hub deploys Auto-Scaling gateways that handle fluctuating levels of traffic from the Internet.
  - The Egress Hub is responsible for outgoing traffic to the Internet.
  - The East-West Hub handles East/West traffic between the spokes and corporate traffic from the On Premises Data Center
- All deployment templates support agile security policies that dynamically learn from cloud subscriptions through tags and metadata

# AWS Architecture Diagrams



# Single Security VPC Hub

Ideal for customers who want a single hub to handle security in AWS. Note that this can add complexity.

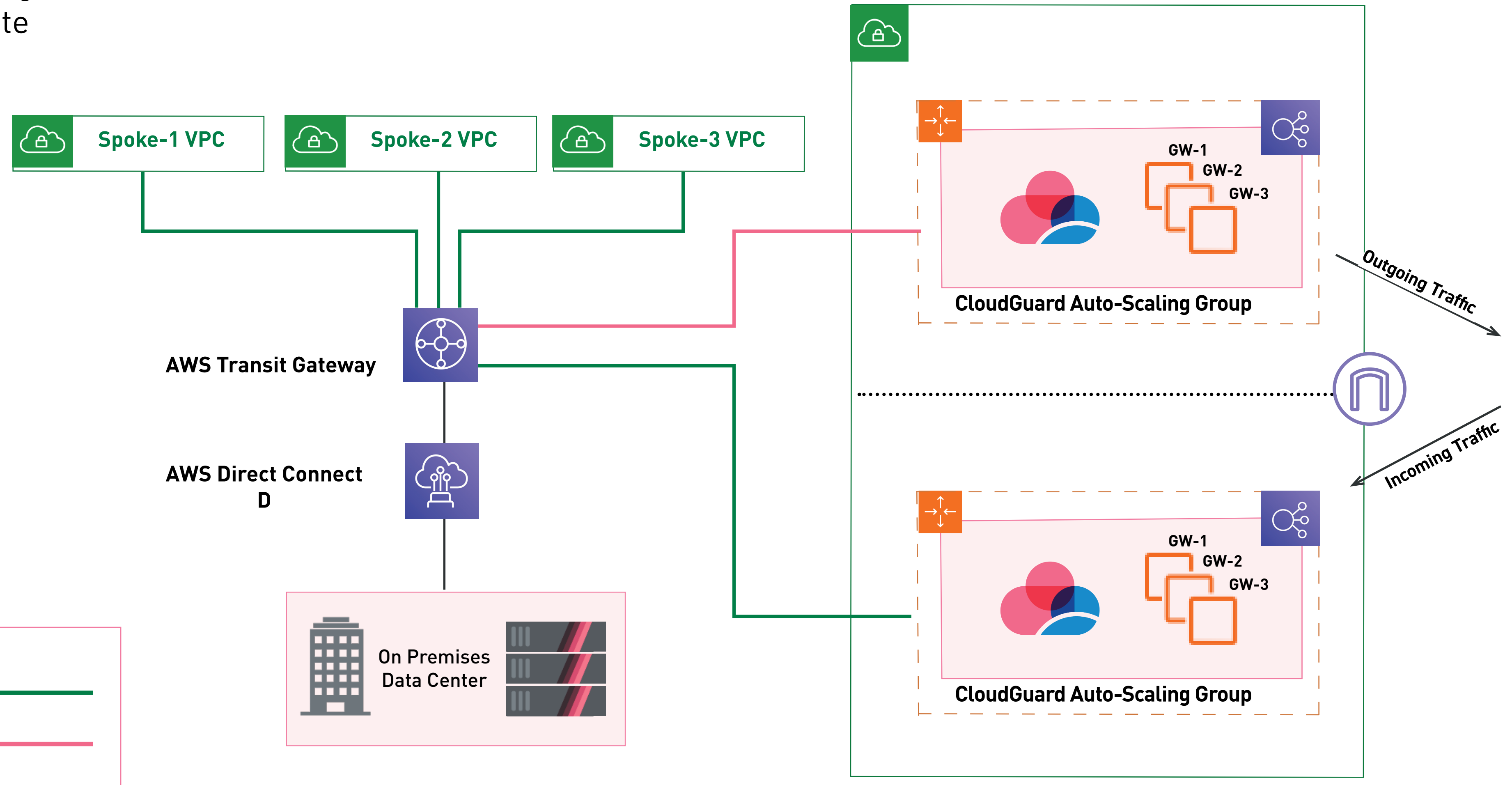

## Values

- Simplest deployment possible
- Native automation using Zero Touch Provisioning
- Ease of management and upgrades through templates
- Independent scaling of Ingress and Egress security controls

## Architecture

- Transit Gateway acts as a central routing hub, to connect VPCs to Internet GWs, on premises networks, and VPC to VPC
- Security Gateways attach to Transit Gateway using IPsec tunnels and BGP peering
- Separate Ingress and Egress templates allow for ease of automation and simplified deployment
- The Ingress traffic Auto-Scaling Groups utilize load balancers for Inbound traffic flows
- The Egress traffic Auto-Scaling Groups attach to the Transit Gateway and process outgoing traffic and East/West traffic between the spokes.

# Two Security VPC - Option 1

## Transit Gateway VPC Attachment for Ingress VPC

Ideal for customers who need scalability with ingress/egress and simplified segmentation routing on the TGW Routing Domains

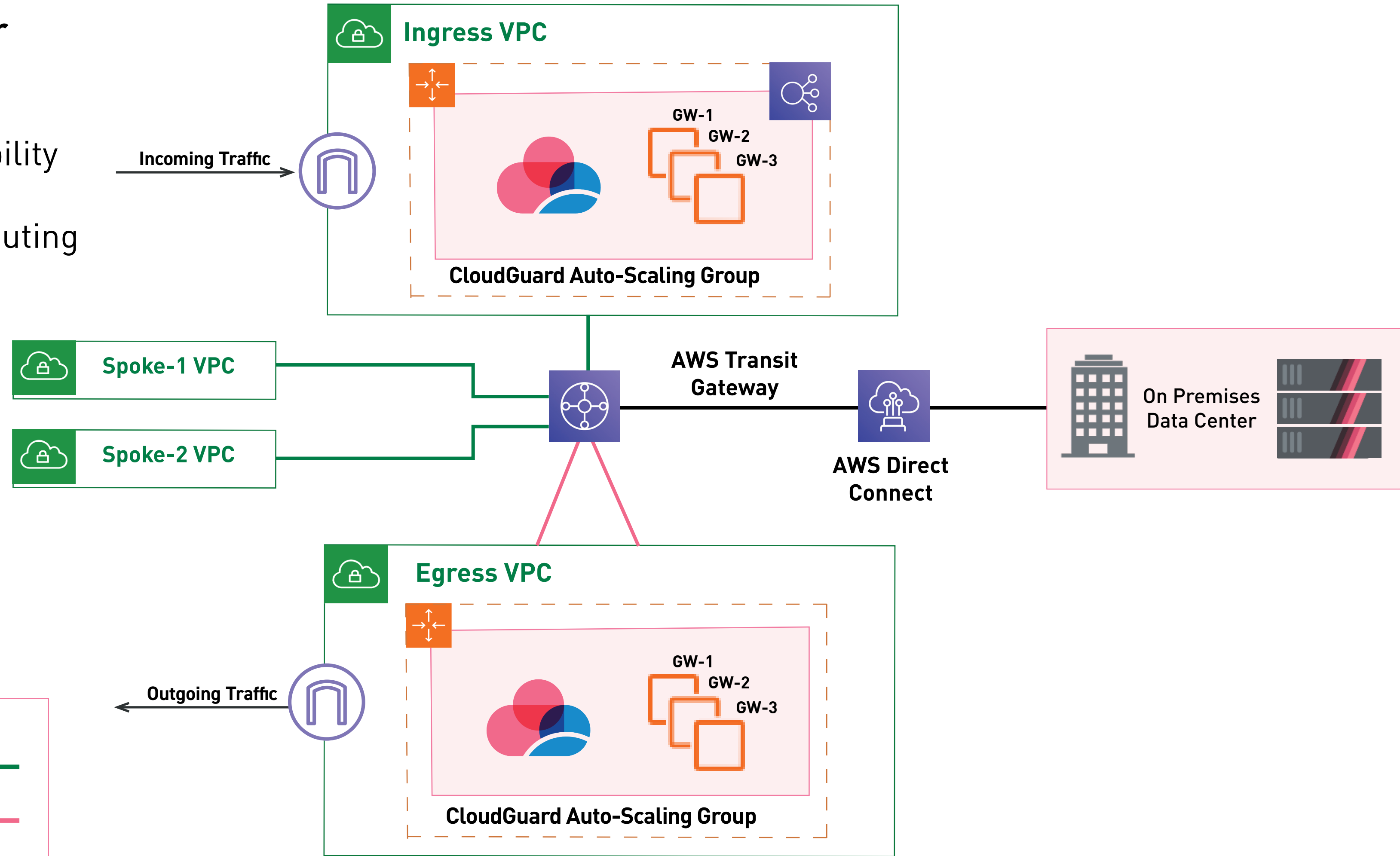

Transit Gateway VPC Attachment

VPN Tunnel

### Values

- Separate fault isolation domains
- Horizontal Elasticity via Active/Active load sharing
- Selective traffic steering for some, all, or no traffic
- Scalable East/West and outgoing traffic if required

### Architecture

- Multiple VPCs are deployed for Ingress and Egress Security Zones.
- Internet Gateways are attached to CloudGuard Auto-Scaling Groups to allow North/South traffic
- The Ingress Auto-Scale Group attaches to load balancers which can be directly attached, peered, and/or connected via Transit GW.
- The Egress VPC handles outgoing traffic, East/West traffic between the Spoke VPCs, and traffic from the on premises data center.
- Vertical scalability by increasing the size of the CloudGuard instances (2 core, 4 core, 8 core)
- Horizontal scalability by increasing the number of CloudGuard instances within the Scaling Group (changing min and max values)
- Following this best practice enables **handling fluctuating traffic load efficiently and independently.**



# Two Security VPC - Option 2

## Security By Design

All the benefits of Option 1, plus a more security-oriented design with ingress traffic controlled per VPC through peering, reducing chance of routing misconfiguration

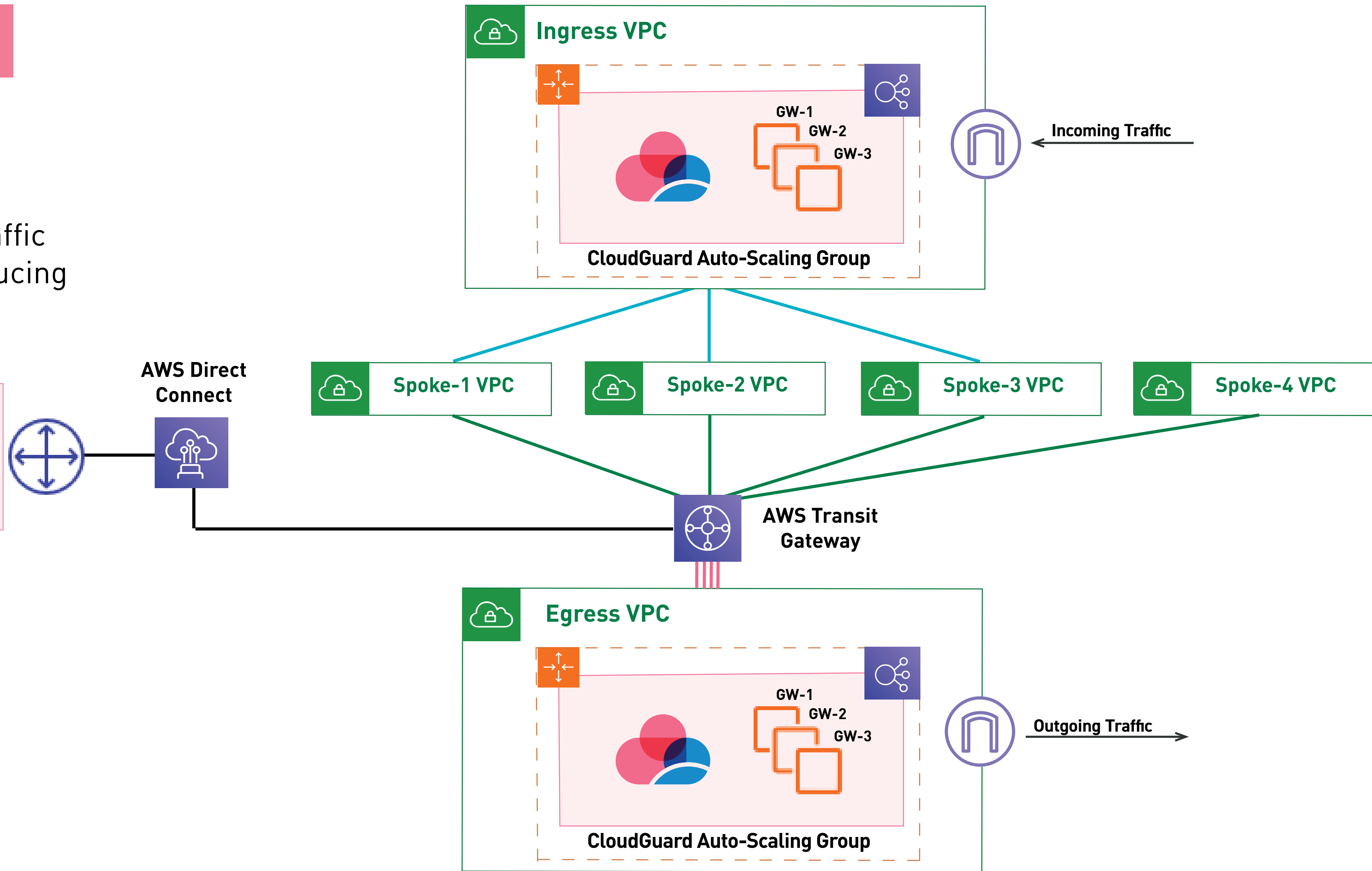
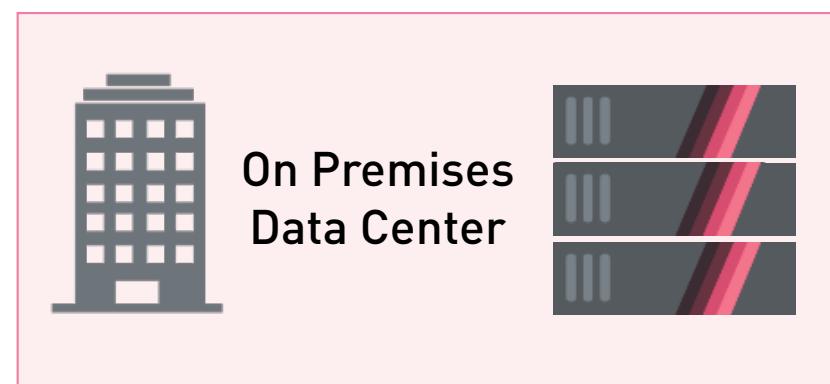

Transit Gateway VPC Attachment

VPN Tunnel

VPC Peering

## Values

- Systematically separate between incoming and outgoing flows
- Ingress traffic flows traverse a shared security zone
- Ingress Auto-Scaling connects through peering
- Spoke VPCs do not contain their own Internet Gateways
- Egress VPC enables on premises to cloud traffic inspection

## Architecture

- The Ingress VPC is peered to the Spoke VPCs, making it so there is no direct connection between the Ingress Hub and the Transit Gateway.
- Selective control for Ingress traffic on a per VPC basis through peering
- Inter-VPC traffic attaches to Transit Gateway, where Layer 3 manipulation allows insertion of Layer 4-7 Security
- The Egress VPC handles outgoing traffic, East/West traffic between the Spoke VPCs, and traffic from the on premises data center.
- Selective performance sizing should be considered for non Auto-Scaling deployments

# Three Security VPCs

## Granular Security Capabilities

All the benefits of 2 Security VPCs, plus optimized throughput. Ideal for customers who do not want SNAT for East/West traffic

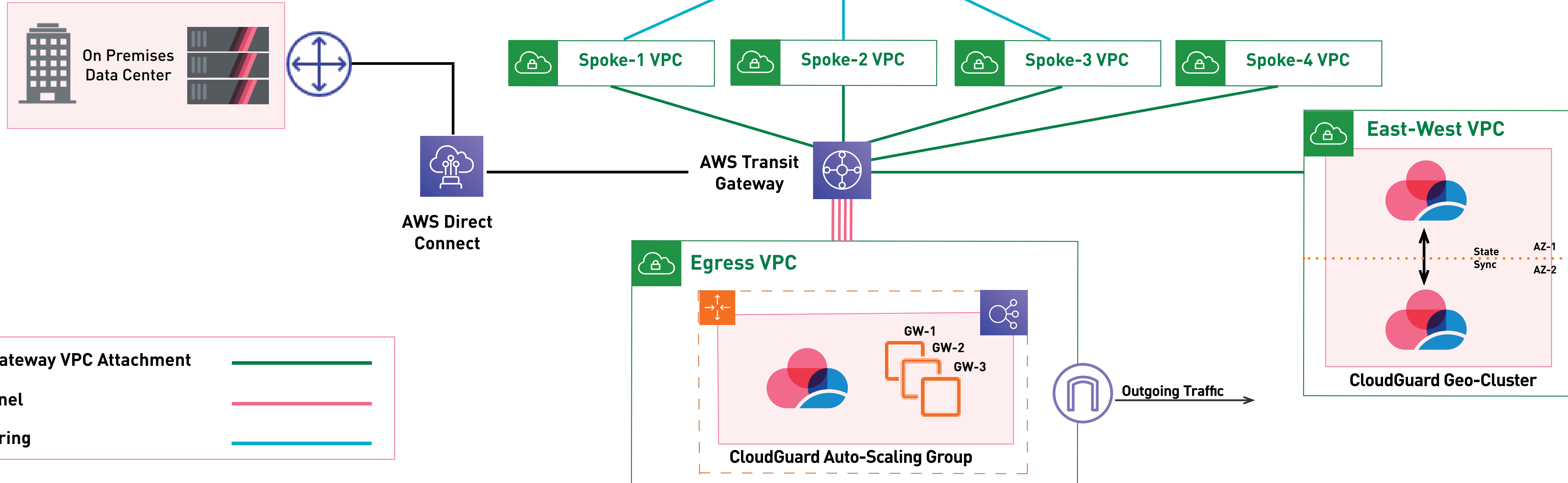

## Values

- Cross AZ State Synchronization and Stateful Failover
- Elimination of SNAT for East/West and Corporate traffic flows
- Common use case for East/West or Direct Connect where SNAT is undesirable
- Greater granularity over network flows (security is enforced separately based upon direction of traffic)
- Isolation of Security Zones provide autonomy

## Architecture

- Independent VPC for East/West and Direct Connect usage uses Active Standby
- CloudGuard Geo-Cluster supports stateful failover where the member that needs to become active automatically changes the routing table in the TGW. This method of failover is faster and takes less API time than the classic cluster failover method. Alternatively, Auto-Scaling Group can be deployed in the East West VPC.
- Creation of separate East/West VPC isolates performance, change control, and policy management from egress security requirements. East/West and Direct Connect have isolation and eliminated need for SNAT

# Gateway Load Balancer

Ideal for customers without the requirement for E/W traffic inspection

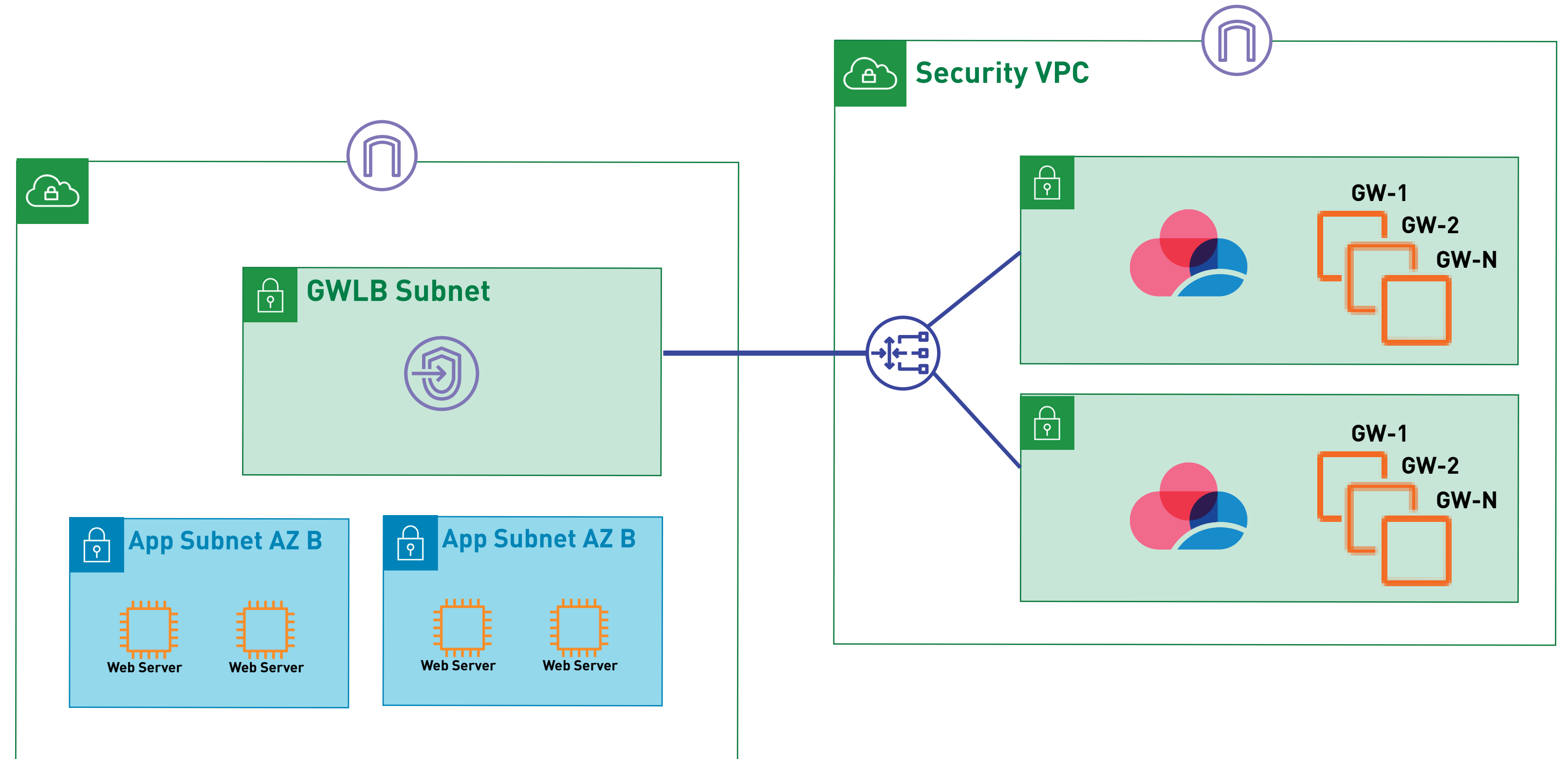

GWLB connection to endpoints



## Values

- Simple per hop routing directs traffic to Security VPC for inspection
- SNAT is not required for GWLB, so original traffic is seen at CG Gateways

## Architecture

- GWLB Endpoint is deployed in its own subnet in the Consumer VPC
- This endpoint will forward all ingress (via Ingress routing edge attachment to IGW) and egress traffic to the GWLB
- GWLB automatically forwards traffic to CG Auto-scaling GWs for enforcement and inspection
- Deploy an Application Load Balancer in Consumer VPC for SSL Termination



# Gateway Load Balancer with Transit GW

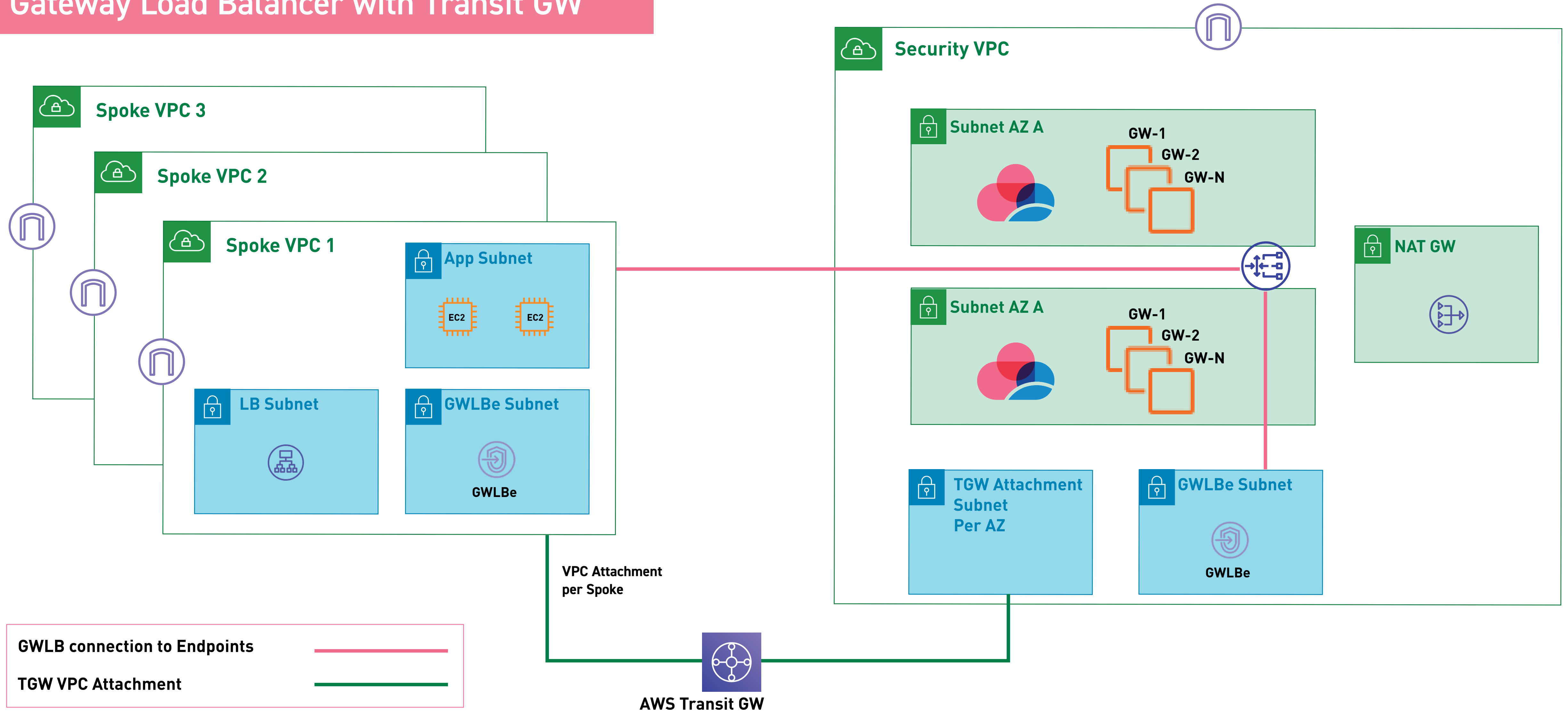

## Values

- SNAT not required to view original outbound, E/W, or encrypted inbound traffic
- Simple per hop routing directs traffic to Security VPC for inspection
- Combined with TGW, eliminates need for IPSec/BGP/ECMP tunnels

## Architecture

- The GWLBe in the Spoke VPCs will forward ingress traffic to the GWLB and automatically to CG enforcement via ingress routing edge attachment to IGW
- IGW must be deployed in every spoke for this inbound inspection
- For SSL offloading of ingress traffic, deploy an Application Load Balancer subnet per AZ
- The GWLBe in the Security VPC forwards egress and E/W traffic to the GWLB and automatically to CG enforcement
- A NAT GW is deployed per AZ to handle outbound traffic NAT translation

# Azure Architecture Diagrams

# Single Security vNet

Ideal for customers who want very simple routing that works for both small and large environments

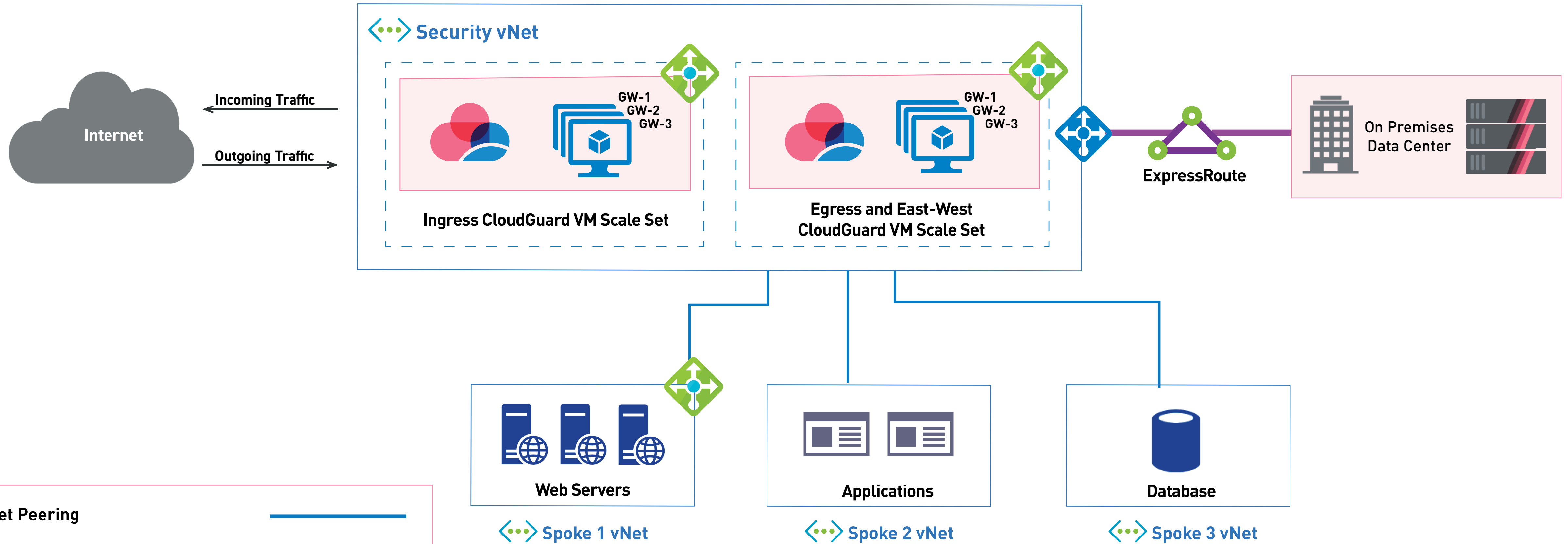

## Values

- Incredible scalability and resiliency
- Highly automated
- Intra-vNET and micro segmentation simplified through use of UDRs
- Inter and Intra vNET Security Deployments supported
- Ability to do host to host micro-segmentation
- On demand and elastic remote access

## Architecture

- All security controls are deployed in one vNET.
- Inbound traffic flows through an External Load Balancer hosting the public IP addresses.
- Outbound traffic flows match UDRs which can be sent to single GWs, HA clusters, and/or VMSS
- With VMSS, UDRs point to the Microsoft standard load balancer attached to HA ports comprised of a CloudGuard VMSS
- Such UDRs eliminate the need for route table manipulation during failover, heavily reducing downtime
- VMSS with UDRs can be used inter or intra vNETS, ExpressRoutes, VPN, and/or micro-segmentation



# Two Security vNet

Ideal for customers desiring better segmentation for traffic flows, with ability to easily send desired traffic flow to a dedicated hub and choose which spokes are exposed to internet.

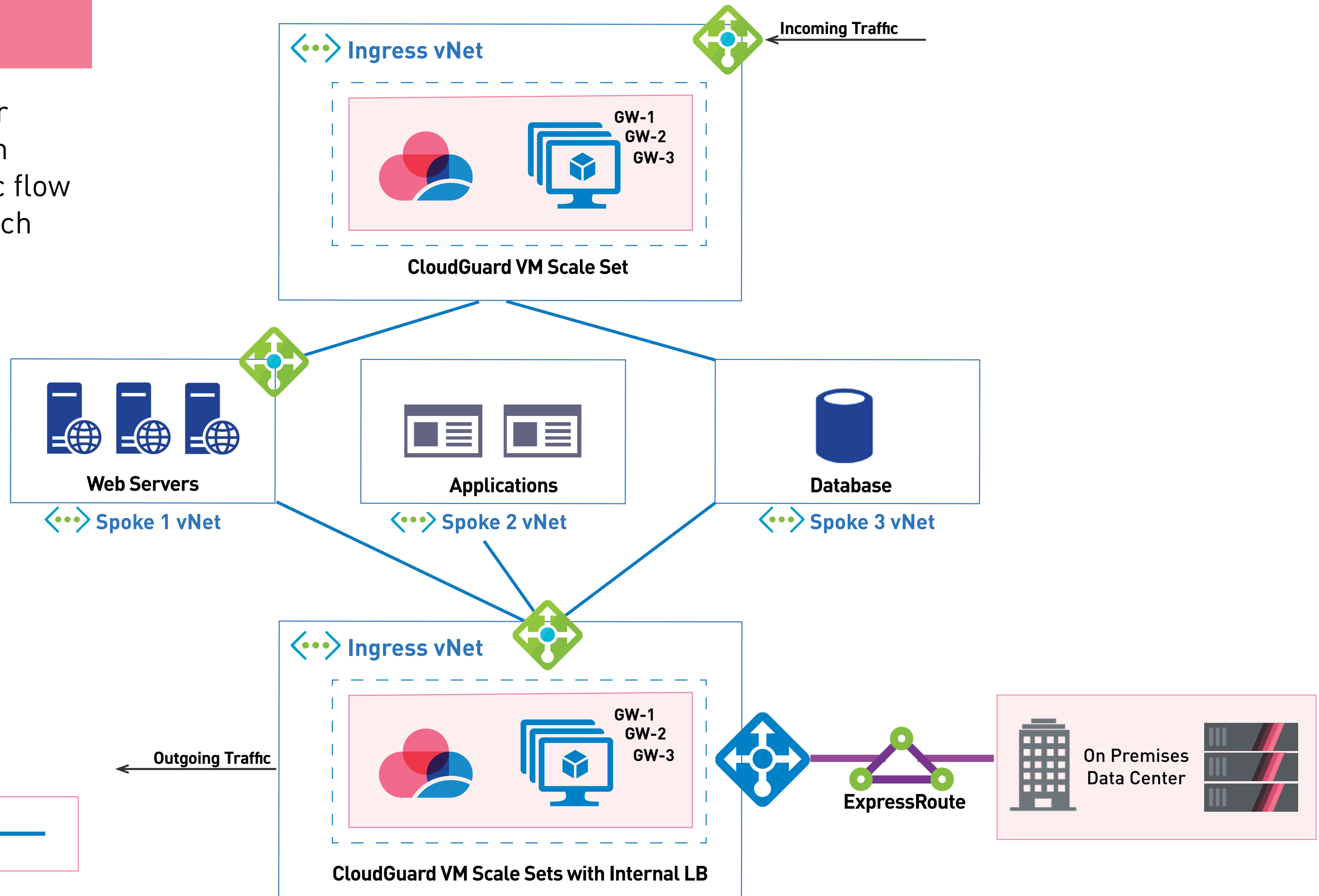

vNet Peering

## Values

- Security by design – Zero Trust Model
- Systematically separate between incoming and outgoing traffic flows
- Traffic flow isolation for performance and policy optimization
- On demand and elastic remote access

## Architecture

- Two vNETs with separate security controls. All the vNETs are connected through peering.
- Security by design. Spokes which do not require Internet connection are not peered to the Ingress vNET, preventing the risk for a routing configuration error. This can be addressed also with CloudGuard CSPM.
- In the Ingress vNET, Inbound traffic flows through an External Load Balancer hosting the public IP addresses.
- The Egress vNET handles East/West traffic, outgoing traffic, and the communication to the on premises data center.
- ARM Templates for single GW, HA Cluster, and/or VMSS are available to meet performance and availability options

# GCP Architecture Diagrams

# Inbound MIG

Ideal for customers who need a dynamic and scalable solution to handle unpredictable inbound traffic flows

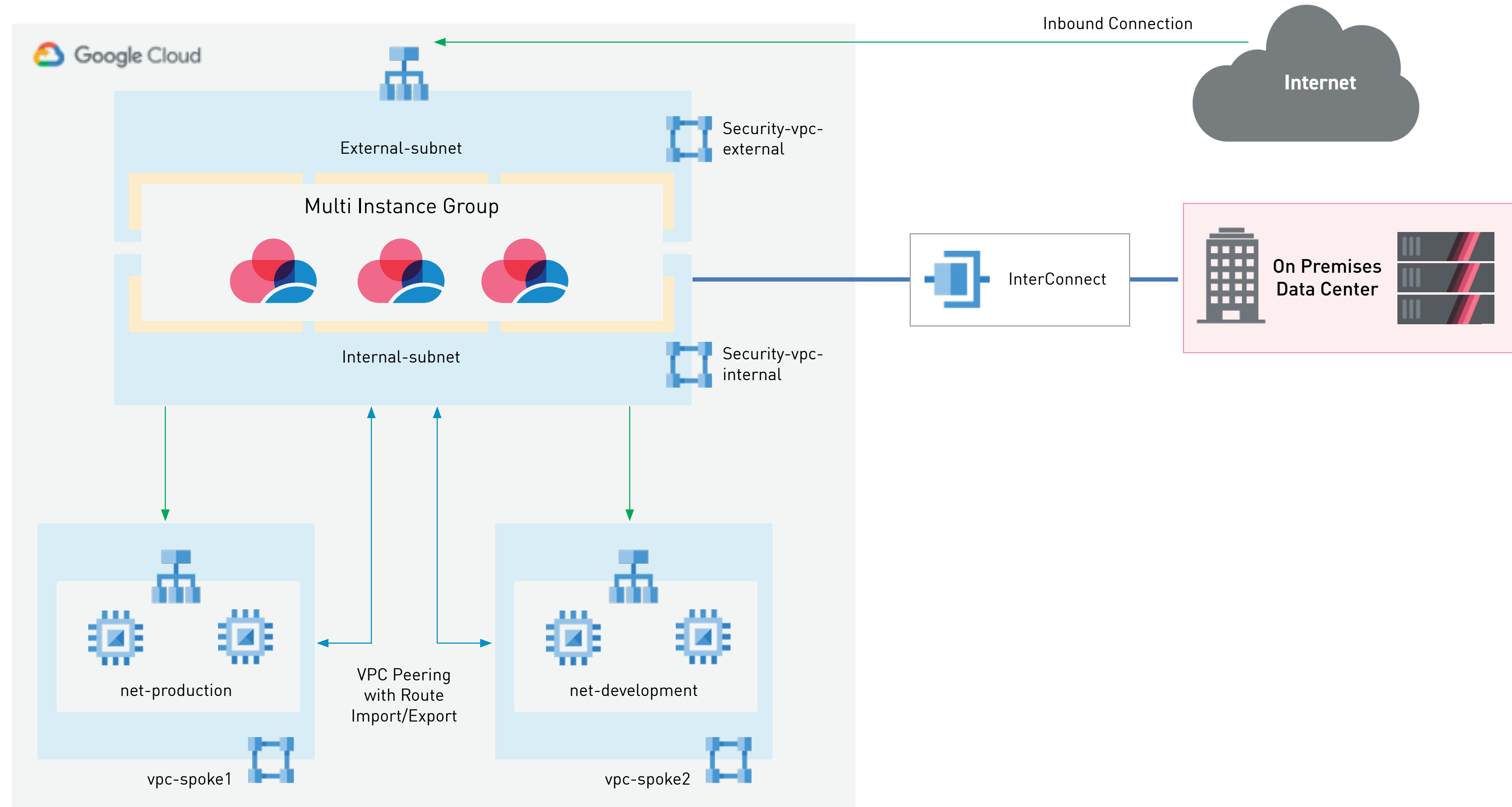

VPC Peering



Traffic Flow



## Values

- Grows with demand for ingress automatically
- Take full advantage of compute that's provisioned. No idle compute, only when needed
- Scalable deployment for exposing back-end applications/services with Multi Instance Group (MIG)

## Architecture

- Automatically provisioned MIG instances with Cloud Management Extension (CME)
- MIGs are deployed in both the external and internal VPC, with interfaces in both
- Load balancer on the external subnet of the external VPC receives inbound connections from the internet and distributes across the MIG instances
- Back End Spoke VPCs are peered to the internal VPC
- Traffic automatically forwarded from MIGs to back-end internal load balancer serving the spokes.



# Outbound and E/W Traffic MIG

Ideal for customers without publically facing assets who have no need for VPN.

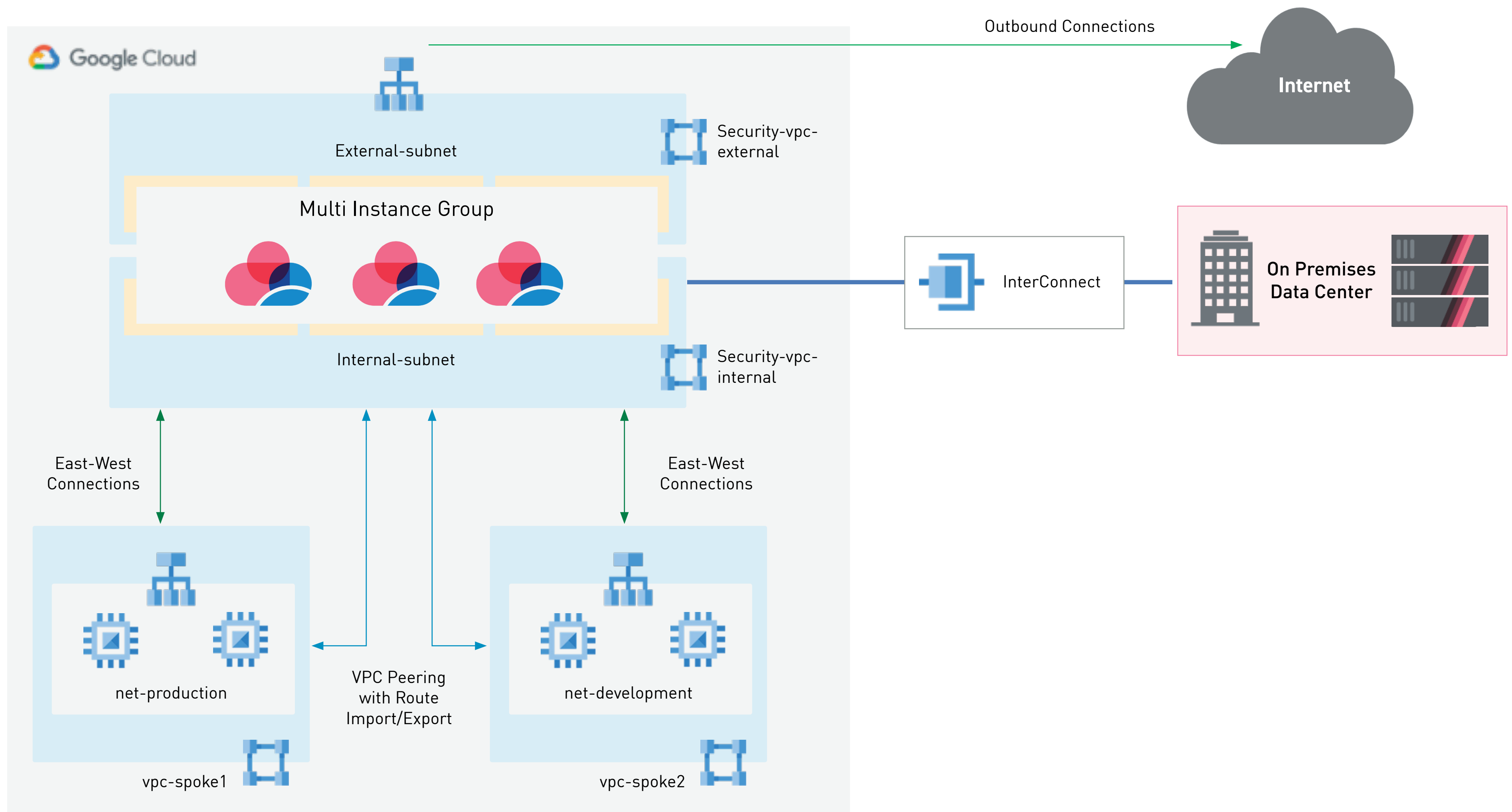

**VPC Peering** —————

**Traffic Flow** —————

## Values

- Good for something that grows with demand for E/W and egress
- Active/active load sharing takes advantage of all the GCP Compute and Check Point licenses
- Scalable deployment with Multi Instance Group handling E/W and Egress flows

## Architecture

- All VPCs must be in the same region for this architecture
- Egress and E/W traffic relies on internal TCP/UDP load balancer in the internal Security VPC
- All spoke VPCs have a default route pointing to the internal load balancer
- Route exchange (import/export) between spoke and security internal VPC
- Does not support ingress flows
- Note that Outbound Autoscaling solution to be released later this year will replace this

# Hub & Spoke HA

Ideal for customers who want a single deployment at enterprise scale, without any interface limits.

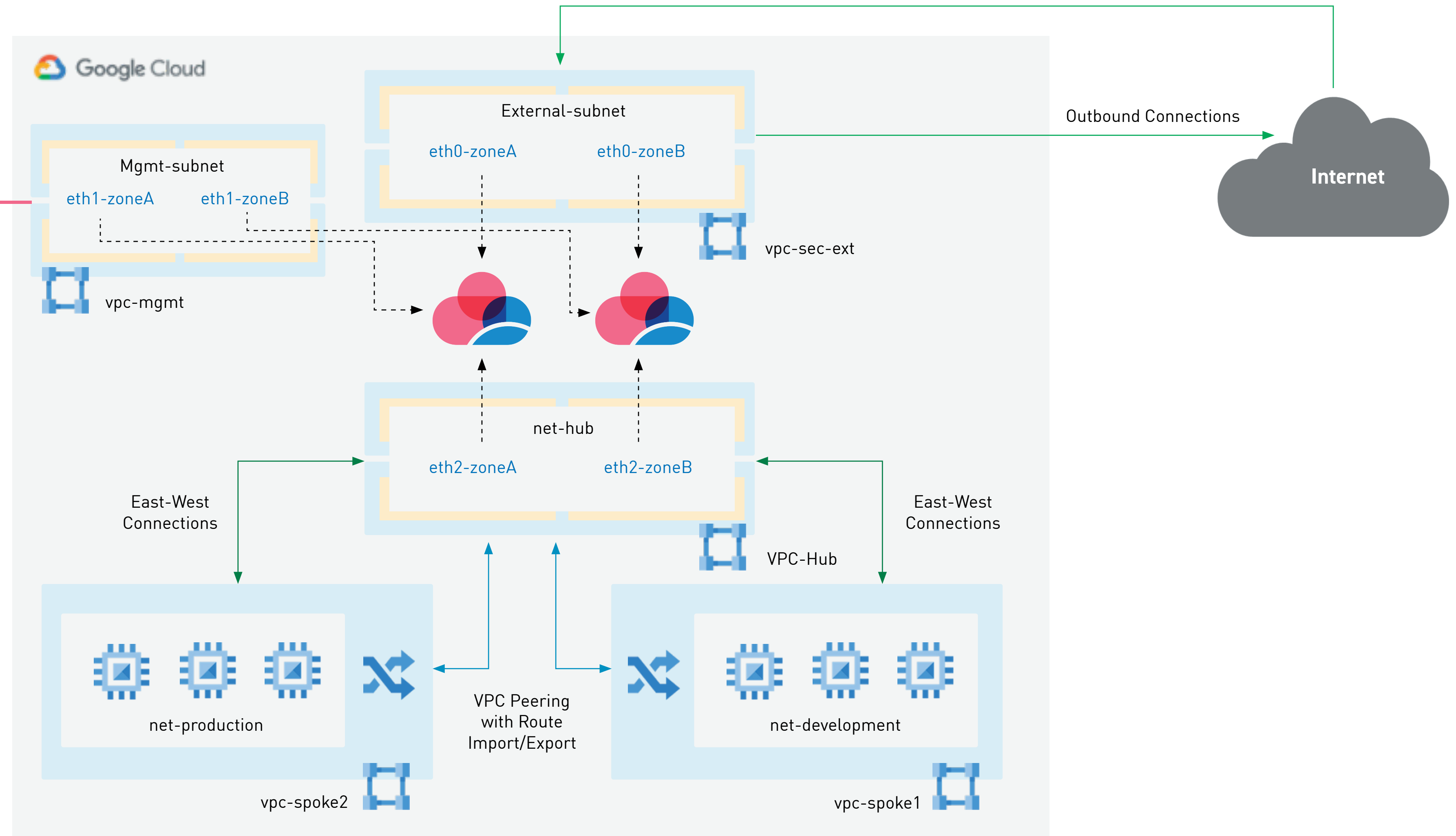
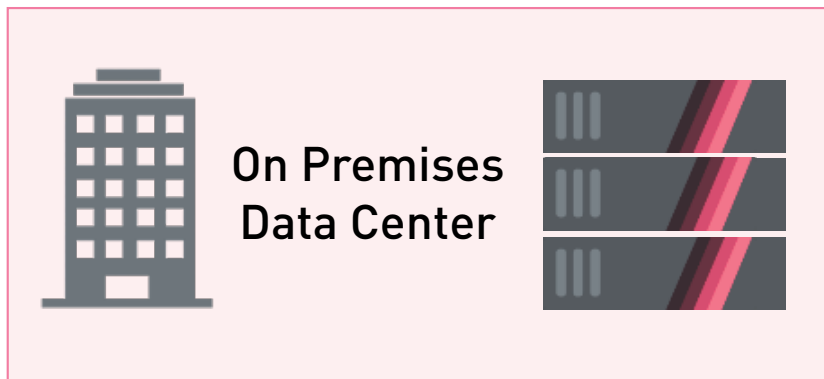

**VPN Tunnel** —

**VPC Peering** —

**Traffic Flow** —

## Values

- Good for something that grows with demand for E/W and egress
- Active/active load sharing takes advantage of all the GCP Compute and Check Point licenses
- Scalable deployment with Multi Instance Group handling E/W and Egress flows

## Architecture

- All VPCs must be in the same region for this architecture
- Egress and E/W traffic relies on internal TCP/UDP load balancer in the internal Security VPC
- All spoke VPCs have a default route pointing to the internal load balancer
- Route exchange (import/export) between spoke and security internal VPC
- Does not support ingress flows
- Note that Outbound Autoscaling solution to be released later this year will replace this

# Two Security VPCs

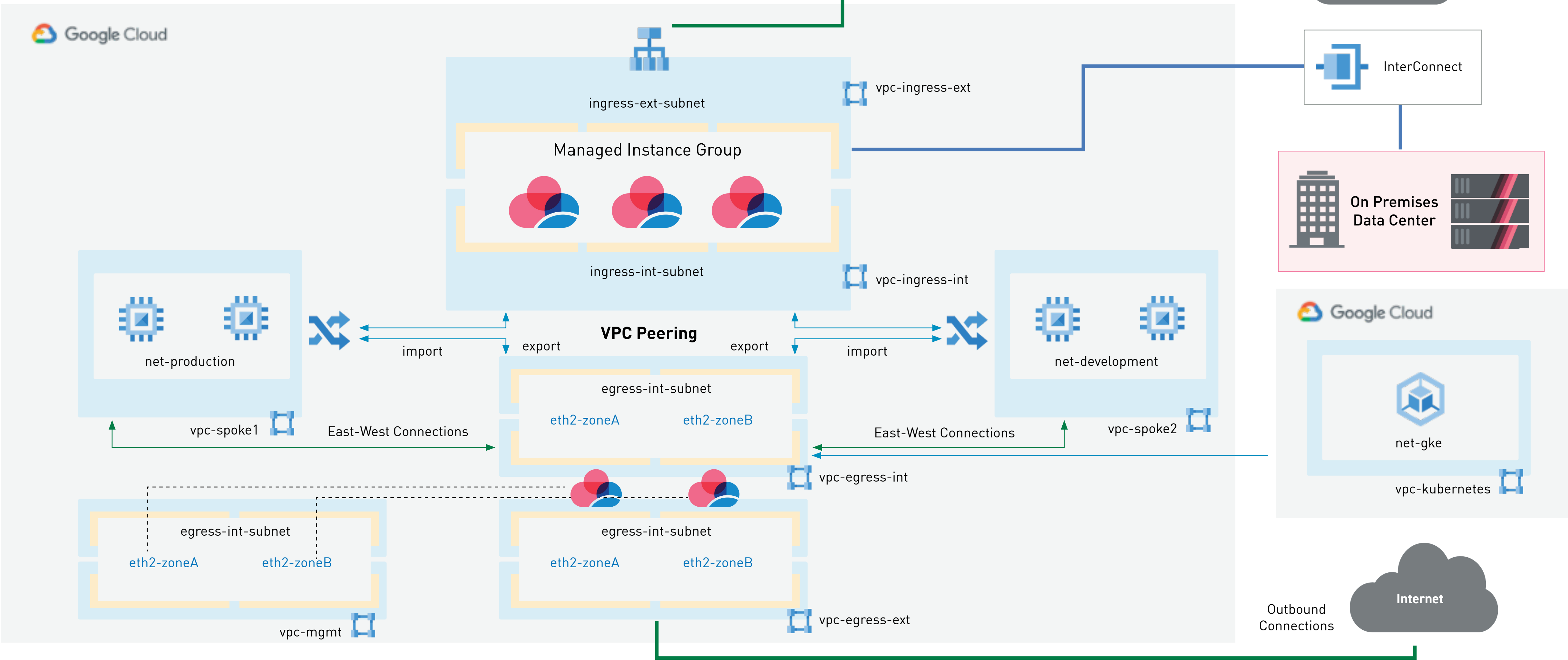

## Values

- SNAT not required to view original outbound, E/W, or encrypted inbound traffic
- Simple per hop routing directs traffic to Security VPC for inspection
- Combined with TGW, eliminates need for IPSec/BGP/ECMP tunnels

## Architecture

- The GWLBe in the Spoke VPCs will forward ingress traffic to the GWLB and automatically to CG enforcement via ingress routing edge attachment to IGW
- IGW must be deployed in every spoke for this inbound inspection
- For SSL offloading of ingress traffic, deploy an Application Load Balancer subnet per AZ
- The GWLBe in the Security VPC forwards egress and E/W traffic to the GWLB and automatically to CG enforcement
- A NAT GW is deployed per AZ to handle outbound traffic NAT translation