

MAESTRO HYPERSCALE ORCHESTRATOR

140 | 170

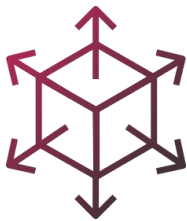

Check Point Maestro brings scale, agility and elasticity of the cloud on premise with efficient N+1 clustering based on Check Point HyperSync technology, maximizing the capabilities of your existing security gateways. Create your own virtualized private-cloud premise by stacking multiple Check Point security gateways together. Group them by security feature set, policy or the assets they protect and further virtualize them with virtual systems technology. With the Maestro Hyperscale Orchestrator, businesses of all sizes can have cloud-level security on premise. Add compute to meet your needs using Maestro Web UI or RESTful APIs – all while minimizing the risk of downtime and maximizing your cost efficiency.



Security at Hyperscale

On demand expansion available to gateways of all sizes



Operational Supremacy

Opening up new simple ways to architect and manage cyber security

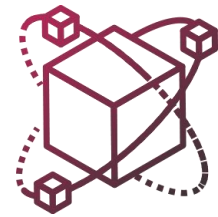

Cloud-Level Resiliency

Delivering the highest standard of resiliency with Telco-Grade Technology



MAESTRO
HYPERSCALE ORCHESTRATOR



6800 Security Gateway

450 Gbps



Up to 52 appliances

26.7 Gbps
17.8 Gbps
8.9 Gbps

Threat Prevention

MAESTRO HYPERSCALE ORCHESTRATOR

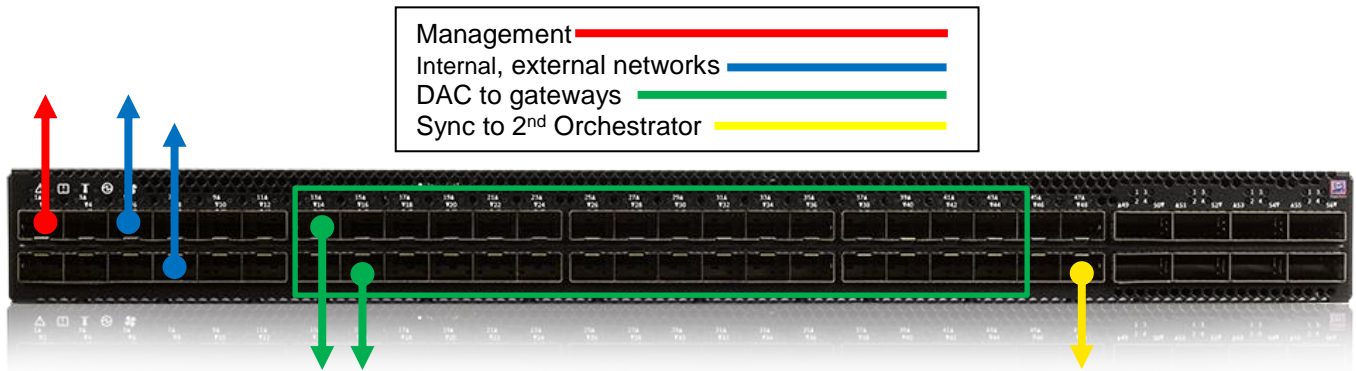



Figure 1: Security Orchestrator 140 Simple Connection Example

The Hyperscale Orchestrator 140 is a mid-range model with 48x 10GbE and 8x 100 GbE ports with a total fabric capacity of 2 to 4 Tbps. The Hyperscale Orchestrator 170 is a high-end model with 32x 100 GbE ports and a total fabric capacity of 3.2 to 6.4 Tbps.

For additional capacity, deploy two Orchestrators of the same model together. Security Group members connect to the Orchestrator via Direct Attached Cables (DAC), either 10 GbE or 40 GbE depending upon the gateway and Orchestrator models deployed. The Orchestrator’s 300-nanosecond port-to-port latency deliver predictable wire speed performance with no packet loss for any packet size.

Maestro Hyperscale Orchestrator	 MHO 140	 MHO 170
Fabric Capacity	4 Tbps	6.4 Tbps
Latency	300 nsec port to port	300 nsec port to port
Ports	48x 10GbE and 8x 100 GbE	32x 100 GbE
Enclosure	1RU	1RU
Standard Dimensions (W x D x H)	17.24' 'x 17' 'x 1.72"', 438 x 436 x 43.8mm	16.84' 'x 27' 'x 1.72"', 427.83 x 686 x 43.8mm
Weight	18.8lb (8.52kg)	24.5lb (11.1kg)
Power Input	100-127 VAC, 200-240VAC, 50-60Hz	100-127 VAC, 200-240VAC, 50-60Hz
Single Power Supply Rating	165W	150W

WELCOME TO THE FUTURE OF CYBER SECURITY

SECURITY GROUPS

With Maestro, you can dynamically allocate or deallocate compute resources within and between Security Groups to meet your needs. Security Groups are logical groups of appliances providing active/active cluster functionally segregated from other Security Groups. Each Security Group has dedicated internal and external interfaces and may have a different configuration set and policy, e.g. Next Generation Firewall protecting a data center or Next Generation Threat Prevention providing perimeter protection.

SINGLE MANAGEMENT OBJECT (SMO)

Externally a Security Group is seen as one security gateway or VSX gateway object in the Check Point security management GUI client, SmartConsole. A single IP address per Security Group for management communications and policy install simplifies Security Group management. All configurations, e.g. interfaces or IP addresses and routes are mirrored on gateways in the Security Group. Prior to becoming an online member and actively handling traffic each new member of the Security Group synchronizes its image, software configuration and security policy with the SMO of the Security Group.

SECURITY SOFTWARE

Maestro members run R80SP.20, the latest version of the field-tested and proven software that was first introduced in 2012 on our Check Point chassis security systems and now integrated into our R80.x main train release.

This includes Next Generation Threat Prevention (NGTP) and NGTP plus SandBlast Zero-day Threat Protection to protect you from the unknown threats.

With R80SP.20, you can monitor and manage the Maestro security fabric. Easily see the state of the gateways and the overall performance of your Security Group members.

Do advanced configuration such as setting up network bonds, image management and system optimization.

MAESTRO USER INTERFACE

The screenshot displays the Maestro Orchestrator interface with the following components:

- Unassigned Gateways Table:**

Name	Serial	Downlinks
Check_Point_5900	18098A0067	35,37
Check_Point_5900	18098A0779	36,42
Check_Point_5900	18098A0705	38
Check_Point_5900	18098A0675	39
Check_Point_5900	18098A0777	40
Check_Point_5900	18098A0714	43
Check_Point_5900	18098A0774	44
- Topology View:** Shows a tree structure of Security Groups (Security Group 1, 2, 3) and their associated SMOs (Check_Point_5900) and interfaces (eth1-Mgmt2).
- Unassigned Interfaces Table:**

Name	Type
eth1-07	ethernet
eth1-08	ethernet
eth1-09	ethernet
eth1-10	ethernet
eth1-11	ethernet
eth1-12	ethernet
eth1-45	ethernet
eth1-46	ethernet
eth1-47	ethernet
eth1-49	ethernet
eth1-51	ethernet
eth1-53	ethernet
eth1-53.505	ethernet
eth1-54	ethernet
eth1-54.506	ethernet
eth1-55	ethernet
eth1-55.507	ethernet
eth1-56	ethernet
eth1-56.508	ethernet
eth1-Mgmt4	ethernet
eth2-07	ethernet
eth2-08	ethernet
eth2-09	ethernet
eth2-10	ethernet
eth2-11	ethernet

WELCOME TO THE FUTURE OF CYBER SECURITY

SPOTLIGHT

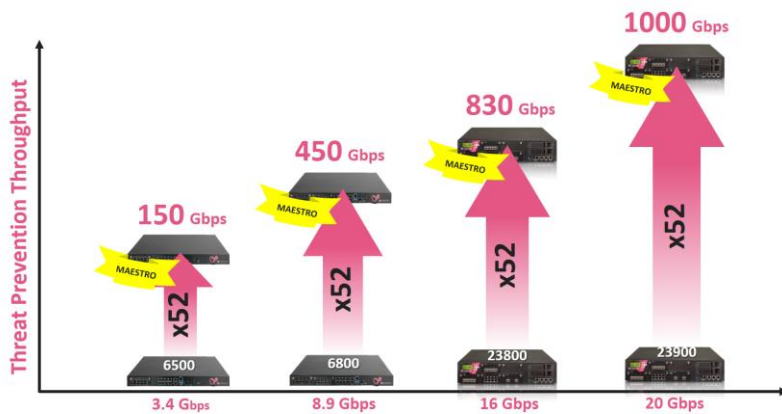

Hyperscale Security System

With Maestro, you can start with 8.9 Gbps, but you can grow, you can easily add existing AND new gateways, up to 52 of them, on demand, and for example, when you start with 8.9 Gbps you can finish with a 450 Gbps security solution. Simply by using Check Point Maestro.

Fully Operational within Minutes

When we add a gateway to the system, it gets all the configurations, the policy, even the software version, updated and aligned with the existing deployment, ready to go within 6 minutes.

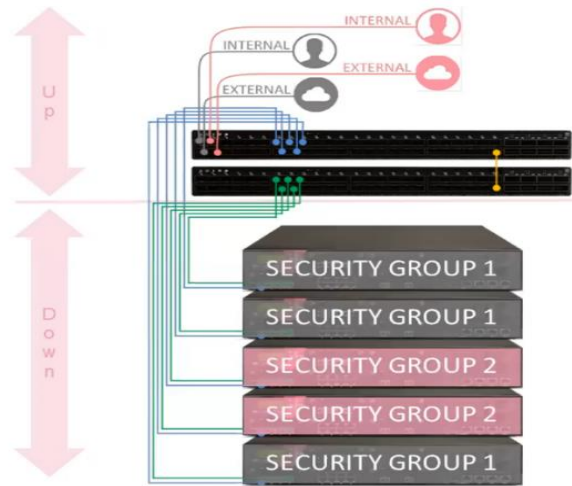

Hyperscale Orchestrator Connections

When a Security Group is created an IP address is created for the SMO management interface connection to the security management server. Easily create and assign IP addresses to the internal and external network interfaces. These uplinks are the visible components of the Maestro security architecture.

Maestro Traffic Distribution

HyperSync tracks the Active/Standby/Backup state of group members, limiting sync traffic to only the Active and Standby members, which are handling the connection. Unicast packets results in a reduction of sync traffic overhead across the Maestro security architecture.

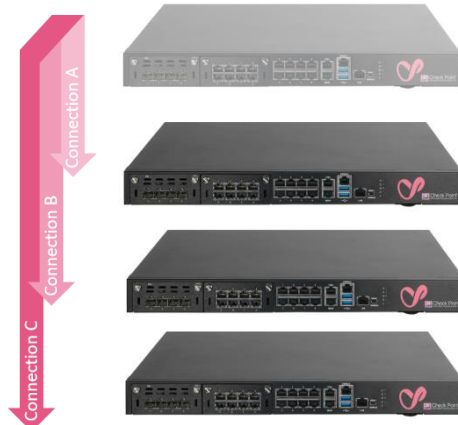

Load



Cost-Efficient N+1 Deployments

We can have an efficient N+1 clustering deployment, under one unified system with the Maestro Security Orchestrator. Now businesses of all sizes can enjoy cloud-level resiliency and telco-grade technology.

Step Up to 5th Generation Cyber Security

Gen V security leaves the patchwork and best-of-breed deployments of the past behind. Instead, it's characterized by an architecture that unifies all networks, cloud, and mobile devices, supported by real time threat intelligence.

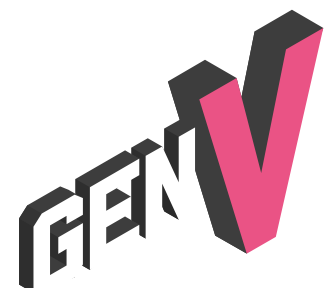

ORDERING MAESTRO HYPERSCALE ORCHESTRATOR

MAESTRO HYPERSCALE SOLUTION PACKAGES	SKU
Maestro Solution with two 23800 Security Gateways and one Orchestrator (MHO-170), including cables	CPAP-MHS-23802
Maestro Solution with three 23800 Security Gateways and one Orchestrator (MHO-170), including cables	CPAP-MHS-23803
Maestro Solution with two 6800 Security Gateways and one Orchestrator (MHO-140), including cables	CPAP-MHS-6802
Maestro Solution with three 6800 Security Gateways and one Orchestrator (MHO-140), including cables	CPAP-MHS-6803
Maestro Solution with two 6500 Security Gateways and one Orchestrator (MHO-140), including cables	CPAP-MHS-6502
Maestro Solution with three 6500 Security Gateways and one Orchestrator (MHO-140), including cables	CPAP-MHS-6503
SECURITY GATEWAY APPLIANCES FOR SCALE-UP	SKU
23800 Security Gateways for Maestro including NGTP subscription for the first year, one 40 GbE NIC and two 40 GbE direct attach cables (DAC)	CPAP-SG23800-MHS
6800 Security Gateways for Maestro including NGTP subscription for the first year, one 10 GbE NIC and two 10 GbE direct attach cables (DAC)	CPAP-SG6800-MHS
6500 Security Gateways for Maestro including NGTP subscription for the first year, one 10 GbE NIC and two 10 GbE direct attach cables (DAC)	CPAP-SG6500-MHS
MAESTRO HYPERSCALE ORCHESTRATORS	SKU
Maestro Hyperscale Orchestrator 140 with 8x 100 GbE and 48x 10 GbE ports	CPAP-MHO-140
Maestro Hyperscale Orchestrator 170 with 32x 100 GbE ports	CPAP-MHO-170
MAESTRO HYPERSCALE ORCHESTRATORS' ACCESSORIES	SKU
Fan replacement for Maestro Hyperscale Orchestrator 170	CPAC-FAN-MHO170
Fan replacement for Maestro Hyperscale Orchestrator 140	CPAC-FAN-MHO140
AC power supply unit replacement for Maestro Hyperscale Orchestrator 140 and 170, with front to back airflow	CPAC-PSU-AC-MHO140/170
Rail kit for Maestro Hyperscale Orchestrators 140 and 170	CPAC-RAIL-MHO140/170
DIRECT ATTACH CABLES	SKU
Direct Attach Cable (DAC) 10GbE SFP+ to SFP+, 1M	CPAC-DAC-10G-1M-B
Direct Attach Cable (DAC) 10GbE SFP+ to SFP+, 3M	CPAC-DAC-10G-3M-B
Direct Attach Cable (DAC) 40GbE QSFP to QSFP, 1M	CPAC-DAC-40G-1M-B
Direct Attach Cable (DAC) 40GbE QSFP to QSFP, 3M	CPAC-DAC-40G-3M-B
Direct Attach Cable (DAC) 100GbE QSFP28, 3M	CPAC-DAC-100G-3M-B
Direct Attach Cable (DAC) 40GbE QSFP to 4xSFP+ 3M	CPAC-DAC-40/10G-3M-B
Direct Attach Cable (DAC) 40GbE QSFP to 4xSFP+ 1M	CPAC-DAC-40/10G-1M-B
23800 SECURITY GATEWAY TRANSCEIVERS	SKU
SFP+ transceiver module for 10G fiber ports - short range (10GBase-SR)	CPAC-TR-10SR-B
SFP+ transceiver module for 10G fiber ports - long range (10GBase-LR)	CPAC-TR-10LR-B
QSFP+ transceiver module for 40G fiber ports - short range (40GBase-SR)	CPAC-TR-40SR-QSFP-300m
QSFP+ transceiver module for 40G fiber ports - long range (40GBase-LR)	CPAC-TR-40LR-QSFP-10Km
Bi-directional QSFP+ transceiver for 40G fiber ports - short range (40GBase-SR-BiDi)	CPAC-TR-40SR-QSFP-BIDI
QSFP28 transceiver module for 100G fiber ports - long range (100GBase-LR4)	CPAC-TR-100LR-B
QSFP28 transceiver module for 100G fiber ports - short range (100GBase-SR4)	CPAC-TR-100SR-B
SFP28 transceiver module for 25G fiber ports with QSFP28 adaptor - short range (25GBase-SR)	CPAC-TR-25SR-B
SFP28 transceiver module for 25G fiber ports with QSFP28 adaptor - long range (25GBase-LR)	CPAC-TR-25LR-B
6000 SECURITY GATEWAYS TRANSCEIVERS	SKU
SFP+ transceiver module for 10G fiber ports - short range (10GBase-SR)	CPAC-TR-10SR
SFP+ transceiver module for 10G fiber ports - long range (10GBase-LR)	CPAC-TR-10LR